

Album Skyrail & Roller Coaster



WARNING:
CHOKING HAZARD -
Toy contains marbles and small parts.
Not for children under 3 yrs.

6430 / 6435 / 6630 / 6660 / 6661 / 6665

ITA Con ROLLER COASTER puoi costruire fantastiche piste sospese per palline, fino a 16 metri di spettacolare sviluppo aereo, diventando così, da subito, il protagonista assoluto della tua cameretta. La pista può essere montata in molti modi diversi: alcuni sono illustrati nelle pagine del manuale incluso, altri puoi crearli tu dando libera espressione alla tua creatività ed inventiva. Con RC le palline non viaggiano solo in discesa a velocità costante (come nei vecchi tipi di corse per palline) ma possono accelerare in strapiombi mozzafiato per poi risalire ripide salite fino quasi a fermarsi e poi percorrere tratti pianeggianti prima del successivo tuffo a tutta velocità verso l'arrivo. RC è stato progettato in modo da poter utilizzare biglie di quasi tutte le dimensioni e materiali (2 tipi inclusi nella scatola). Ogni tipo di pallina percorrerà le rotaie a velocità diverse e ti permetterà di fare interessantissime osservazioni, esperimenti e scoperte nel mondo della fisica, e di comprenderne intuitivamente i principi fondamentali. Questo è un eccezionale valore educativo che fa di RC un unico ed insostituibile strumento formativo.

ENG With ROLLER COASTER you can build fantastic marble suspension tracks up to 16 metres long. Your toy will immediately become the best thing in the room! The tracks can be assembled in many different ways: some are illustrated in the enclosed manual, but you can invent many other ones freely expressing your creativity. With RC marbles don't travel only downward at constant speed like in old-fashion marble runs, but can accelerate impressively

down steep slopes then climb uphill until almost reaching a stop, roll quietly along flat plateaus, and then again deep down chilling plunges at full speed. RC is designed in such way that most types of marbles, in various sizes and materials, can run along its tracks (2 types included in this box). Each marble type will run at different speed and will allow you to observe, experiment and discover the world of physics forces and to understand intuitively its fundamental principles. This is actually an exceptional educational value that makes RC unique and an irreplaceable learning instrument.

FRA Avec ROLLER COASTER, tu peux construire de fantastiques pistes suspendues pour tes billes, jusqu'à 16 mètres de long ! RC deviendra le point d'attraction de votre chambre. La piste peut être montée de nombreuses manières différentes : quelques-unes sont illustrées dans les pages du manuel inclus, d'autres peuvent être créées en exprimant librement votre créativité et votre imagination. Avec RC les billes ne voyagent pas seulement en descente à vitesse constante (comme dans les autres types de courses pour billes), mais elles peuvent accélérer par des sauts époustouffants, remonter des côtes si raides qu'elles s'arrêteraient presque et puis parcourir des plateaux avant de descendre en piqué vers la fin de la piste. RC a été conçu de façon à ce que l'on puisse utiliser presque tous les types de billes que l'on trouve normalement en vente : de 14 mm à 21 mm de diamètre et de n'importe quel matériau et poids : verre, acier, plastique, bois... Chaque type de bille parcourra les rails

à une vitesse différente et cela vous permettra de faire des observations, expérimentations et découvertes très intéressantes dans le monde de la physique et d'en comprendre intuitivement les principes fondamentaux. Ceci est une exceptionnelle valeur éducative qui rend RC un instrument formateur unique et irremplaçable.

ESP Con ROLLER COASTER puedes construir fantásticos circuitos para canicas de más de 16 metros de largo. Será el protagonista absoluto de todos los juegos de tu habitación. Los carriles pueden ser ensamblados de muchas maneras diferentes: algunas de éstas están ilustradas en el manual adjunto, pero usted puede inventar muchas nuevas expresando su creatividad libremente. En el RC las canicas no viajan en una trayectoria descendente constantemente, como la mayoría de pistas tradicionales de canicas, sino que pueden acelerar impresionantemente en una pendiente pronunciada y luego subir por el riel casi hasta detenerse, rodando suavemente a lo largo de una planicie y luego una vez más precipitarse rápidamente en bajada a toda velocidad. RC está diseñado de tal forma que la mayoría de los tipos de canicas (de varios tamaños y materiales) pueden correr por los rieles (2 tipos de canicas incluidas en la caja). Cada tipo de canica correrá a una velocidad diferente y le permitirá observar, experimentar y descubrir el mundo de las fuerzas físicas y entender intuitivamente sus principios fundamentales. Esto, en realidad, hace del RC una herramienta educacional y de aprendizaje excepcional, única e irremplazable.

(DEU) Mit ROLLER COASTER können Sie fantastische Kugelbahnen bauen, welche über 16 Meter lang sind. Skyrail wird sicherlich das beste Spielzeug bei Ihnen zu Hause sein. Die Piste kann auf verschiedene Weise gebaut werden: Einige sind auf den Seiten des beigefügten Handbuchs illustriert, andere kannst du schaffen, indem du deine Schaffenskraft und Erfindungsgabe spielen lässt. Mit RC laufen die Kugeln nicht nur bergab mit konstanter Geschwindigkeit (wie auf anderen Kugelbahnen), sie können auch schneller in aufsehenerregenden Überhängen fahren, nachher wieder steile Aufstiege erklimmen, bis sie fast halten, und dann durch ebene Strecken laufen, bevor sie sich mit voller Geschwindigkeit ins Ziel stürzen. RC ist geplant worden, um Kugeln von fast allen Dimensionen und aus fast allen Materialien benutzen zu können (2 Typen in der Schachtel enthalten). Jeder Kugeltyp wird die Bahnen mit verschiedenen Geschwindigkeiten durchlaufen und das wird dir erlauben, ganz interessante Feststellungen, Experimente und Entdeckungen in der Physikwelt zu machen und darüber hinaus die wesentlichen Grundsätze zu verstehen. Dies ist ein außergewöhnlicher Erziehungswert, der RC zu einem einzigartigen und unersetzbaren bildenden Instrument macht.

6430 / 6435

Roller Coaster

mini & maxi rail

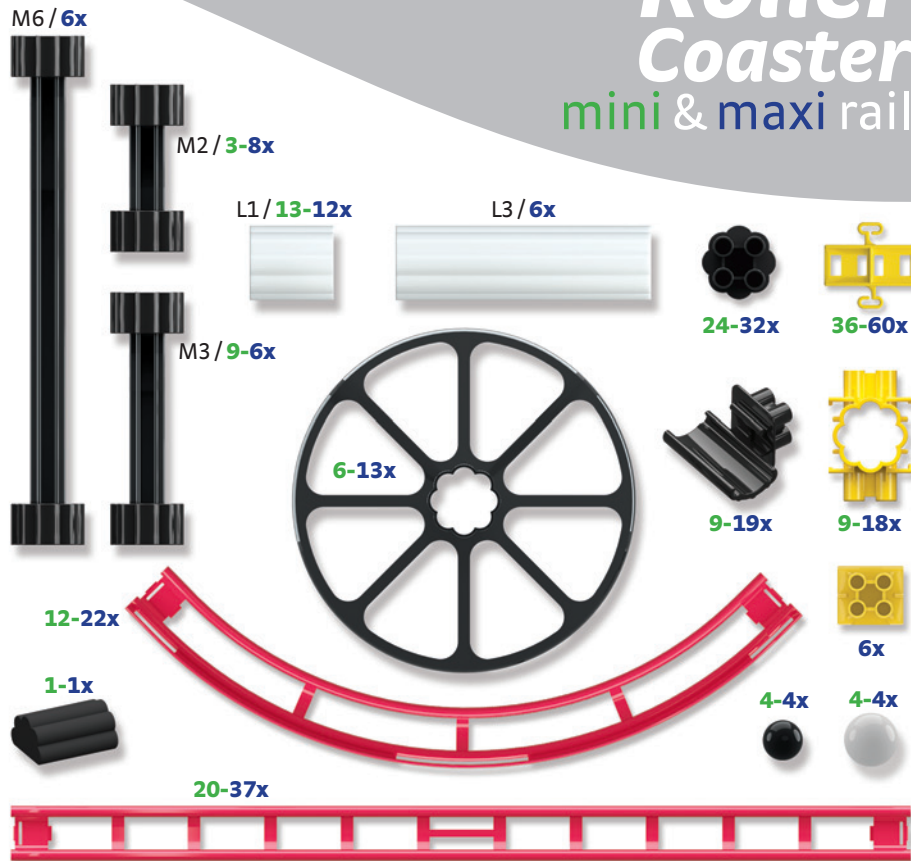

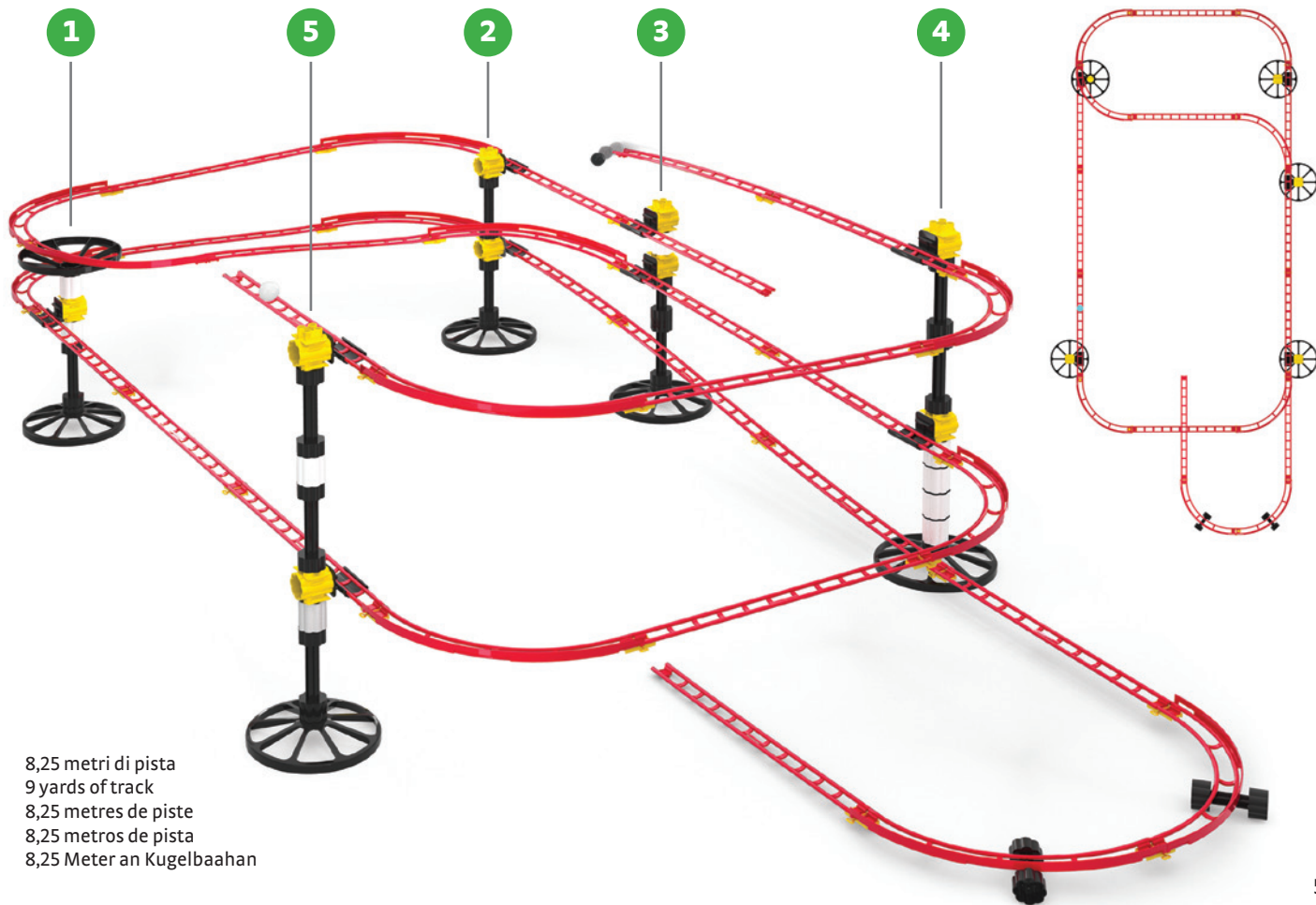

8,25 metri di pista
9 yards of track
8,25 metres de piste
8,25 metros de pista
8,25 Meter an Kugelbaahan

6435 Roller Coaster maxi rail

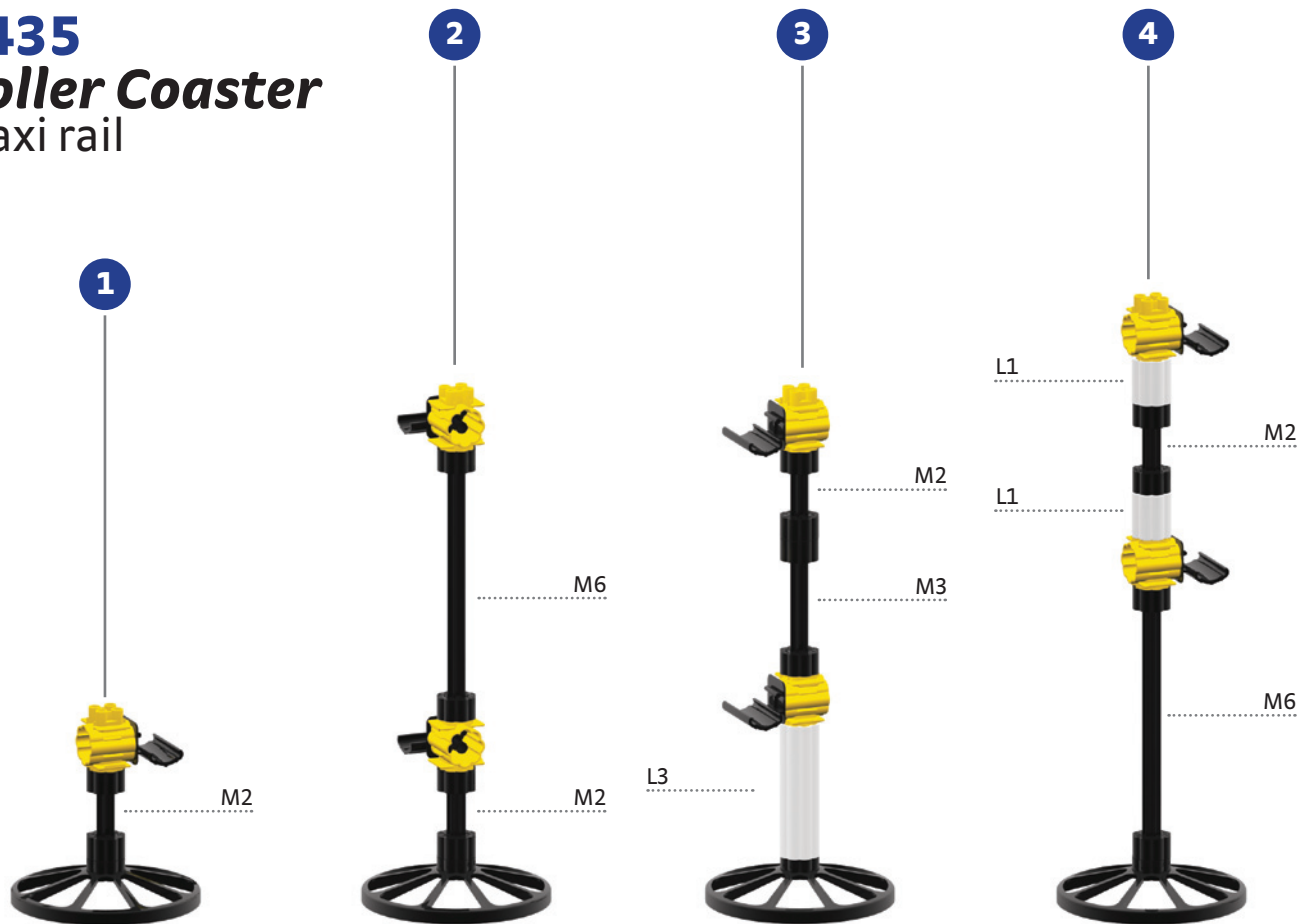

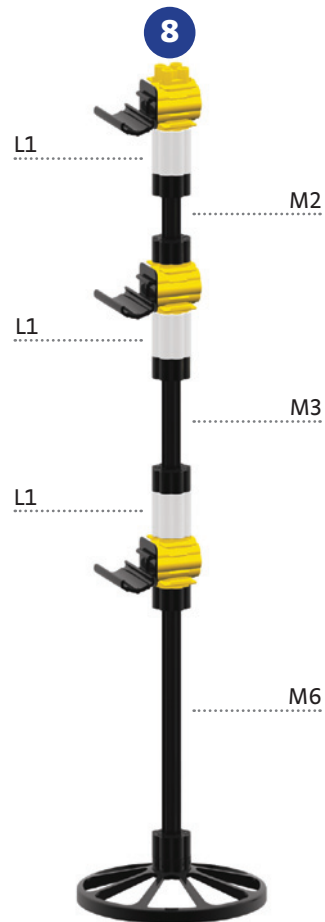
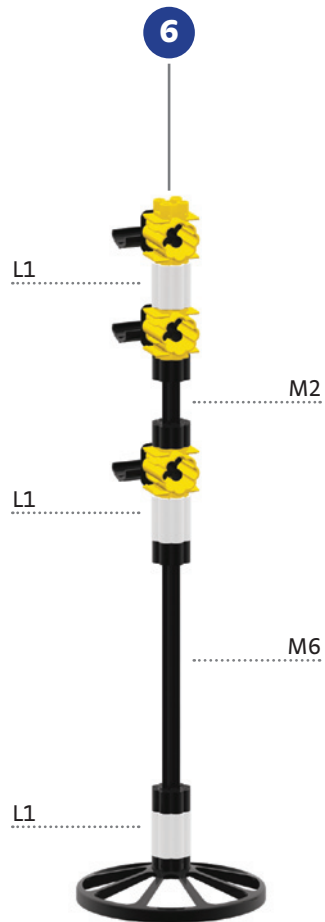
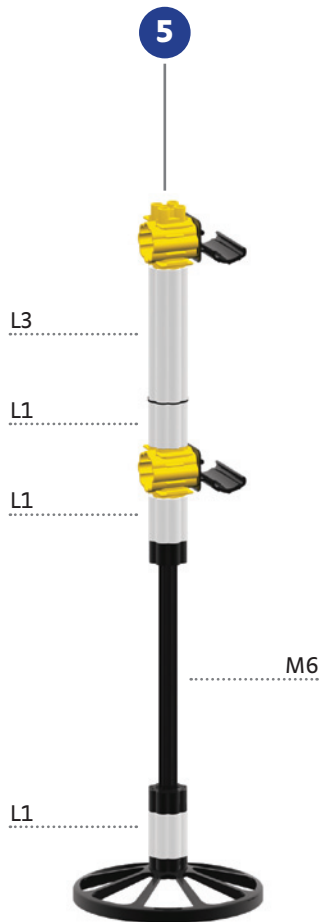

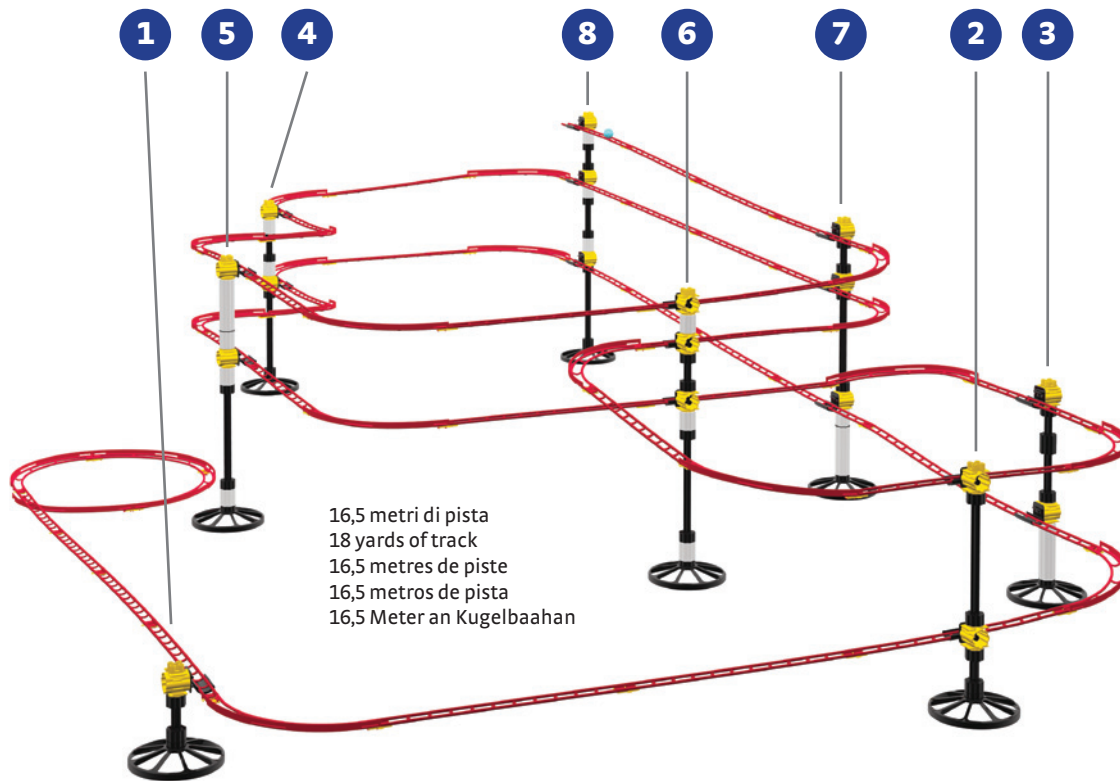

16,5 metri di pista
18 yards of track
16,5 metres de piste
16,5 metros de pista
16,5 Meter an Kugelbaahan

6435 *Roller Coaster* maxi rail



1



Istruzioni di montaggio delle rotaie.
Assembly instructions of the rails.
Instructions de montage des rails.
Las instrucciones de instalación de los rails.
Montageanleitung der Schienen.

2



A



3



B

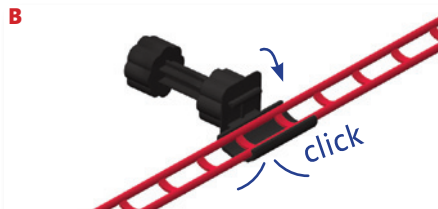

4

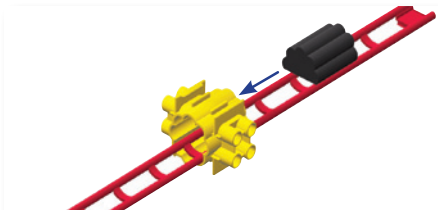

Discesa a 45 gradi, consigliata per costruzioni con loop.
Descent to 45 degrees, recommended for building models with loop.
Descente à 45°, conseillée pour les constructions avec "loop".
Descenso 45 grados, se recomienda para los modelos con bucles.
Gefälle bis zu 45 Grad, empfohlen für Konstruktion mit Looping.

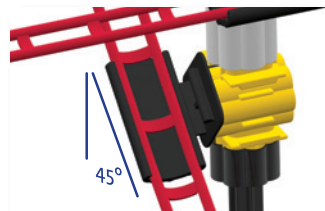

Loop

Rampa elicoidale.
Spiral Ramp.
Rampale hélicoïdale.
Rampa en espiral.
Spiralförmige Rampe.



ITA Con SKYRAIL puoi costruire fantastiche piste sospese per palline, fino a 5 metri di spettacolare sviluppo aereo, diventando così, da subito, il protagonista assoluto della tua cameretta. SKYRAIL è stato accuratamente progettato in modo da poter utilizzare biglie di diverse dimensioni e materiali: ti permetterà, così, di fare interessantissime osservazioni, esperimenti e scoperte nel mondo della fisica (velocità, gravità, forza centrifuga, attrito) e di comprenderne intuitivamente i principi fondamentali. Tutto questo ne fa un gioco dall'eccezionale e unico valore educativo che assicura lunghe ore di gioco, in piena sicurezza, utili e formative.

ENG With SKYRAIL you can build fantastic marble suspension tracks up to 5 metres long. Your toy will immediately become the best thing in the room!

SKYRAIL has been carefully planned in order to use marbles of different dimensions and materials: it allows you to make interesting observations, experiments and discoveries in the world of physics (speed, gravity, strength, centrifuge, attrition) and to intuitively understand fundamental principles. The Skyrail is a safe way to spend hours in a highly educational environment.

FRA Avec SKYRAIL, tu peux construire de fantastiques pistes suspendues pour tes billes, jusqu'à 5 mètres de long ! Skyrail a été développé de telle façon qu'il s'adapte à toutes les tailles et matériaux de billes. Il permet ainsi de faire de super intéressantes observations, expériences et découvertes du monde de la physique (vitesse, gravité, force centrifuge, frottement) mais aussi

d'en comprendre les principes fondamentaux. Tout ceci en fait un jeu d'une valeur éducative exceptionnelle, qui garantit de longs moments de jeu utile et formateur, en toute sécurité.

ESP Con SKYRAIL puedes construir fantásticos circuitos para canicas de más de 5 metros de largo. Será el protagonista absoluto de todos los juegos de tu habitación. Skyrail ha sido cuidadosamente diseñado para ser usado en diferentes situaciones y con canicas de diferentes materiales: permite hacer observaciones, experimentos y descubrimientos del mundo de la física (velocidad, gravedad, fuerza centrífuga, atracción) y entender sus principios fundamentales. El juego Skyrail tiene un gran valor educativo que asegura horas de juego formativo con total seguridad.



Mit SKYRAIL können Sie fantastische

Kugelbahnen bauen, welche über 5 Meter lang sind. Skyrail wird sicherlich das beste Spielzeug bei Ihnen zu Hause sein. Die Kugelbahn wurde sorgfältig geplant unter Berücksichtigung, dass die Murmeln unterschiedliche Größen haben und aus verschiedenen Materialien bestehen. Man kann verschiedene Feststellungen, Experimente und Entdeckungen in der Welt der Physik machen (Geschwindigkeit, Gravitation, Stärke, Fliehkraft, Reibung), um instinktiv die Prinzipien zu verstehen. Skyrail ist ein sinnvoller Weg um die Zeit in erzieherischer Weise zu verbringen.

6630

Skyrail

Suspension basic

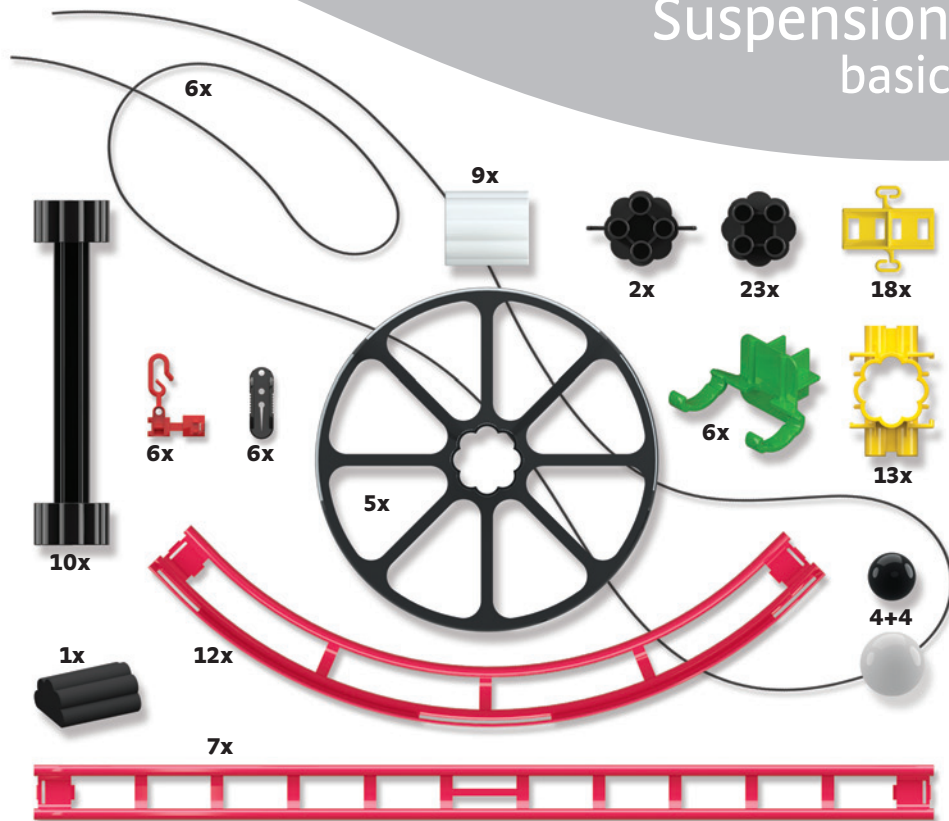

1

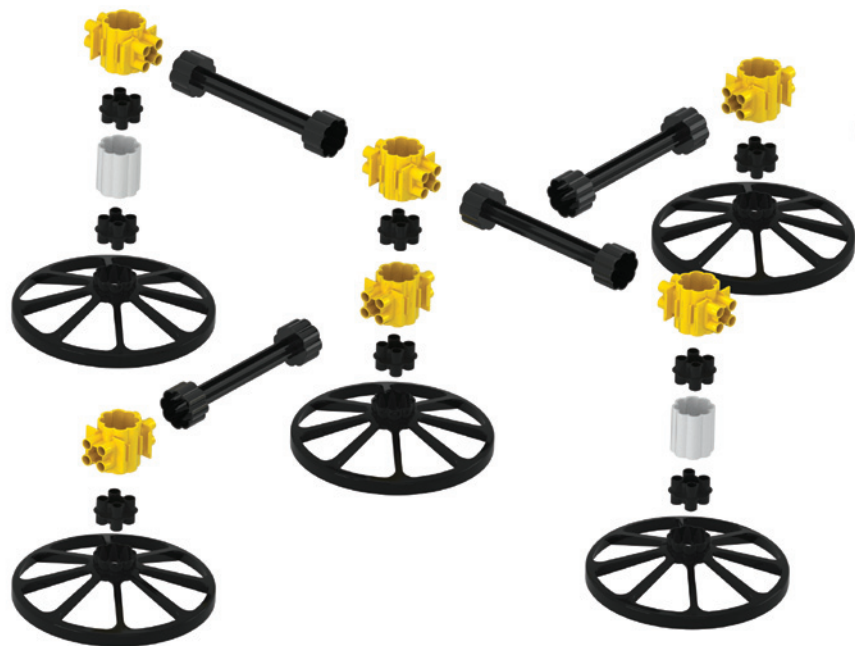

2



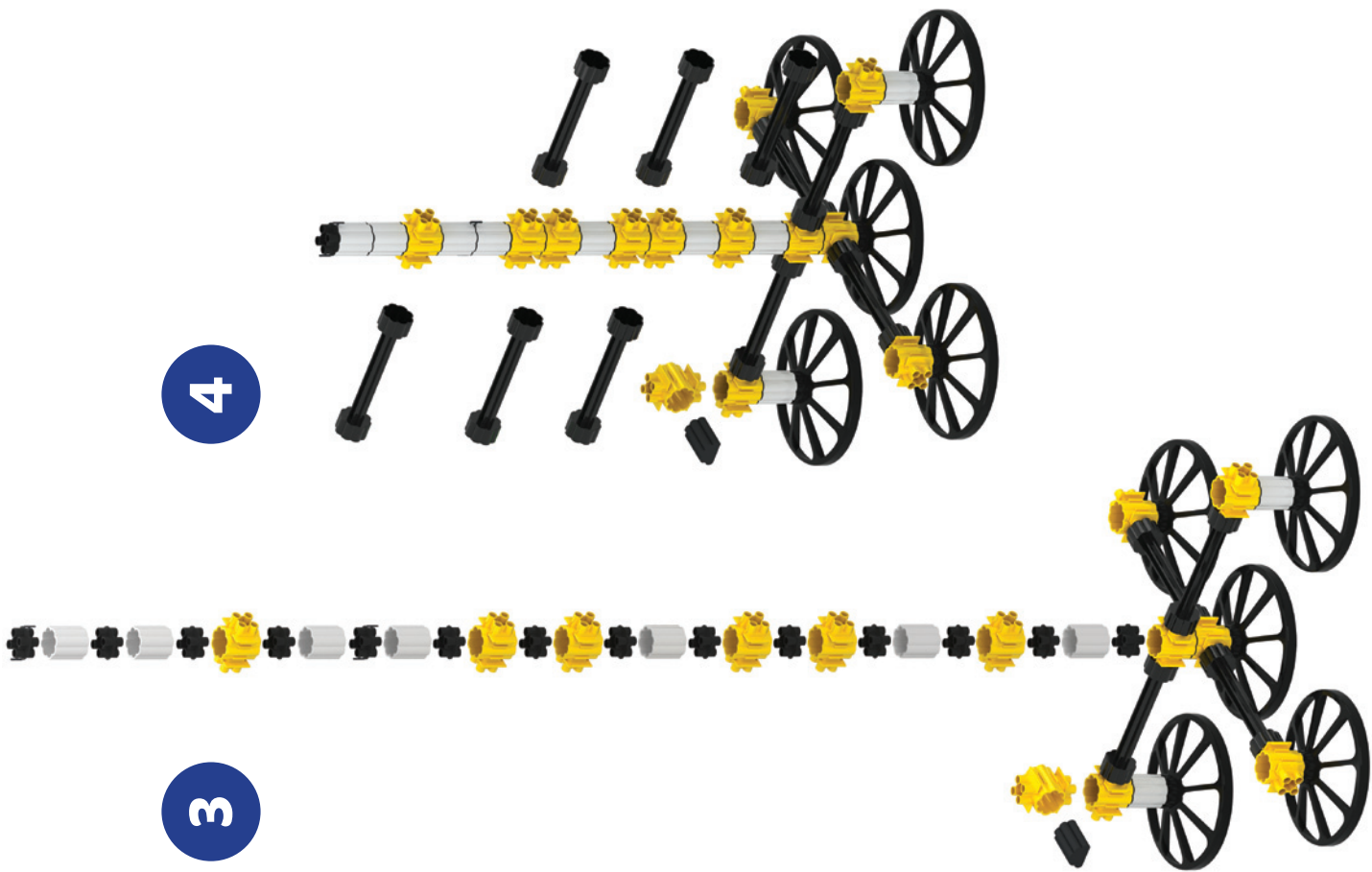

5

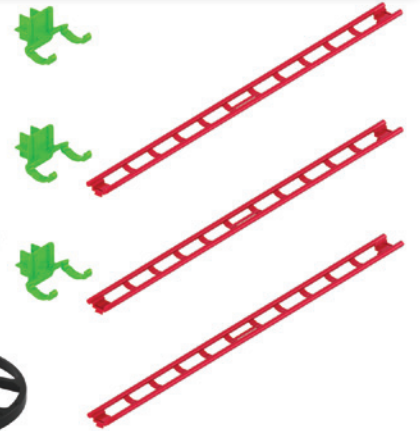
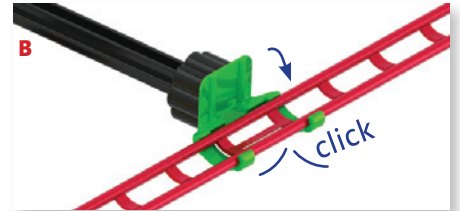
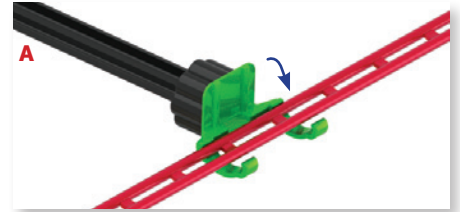
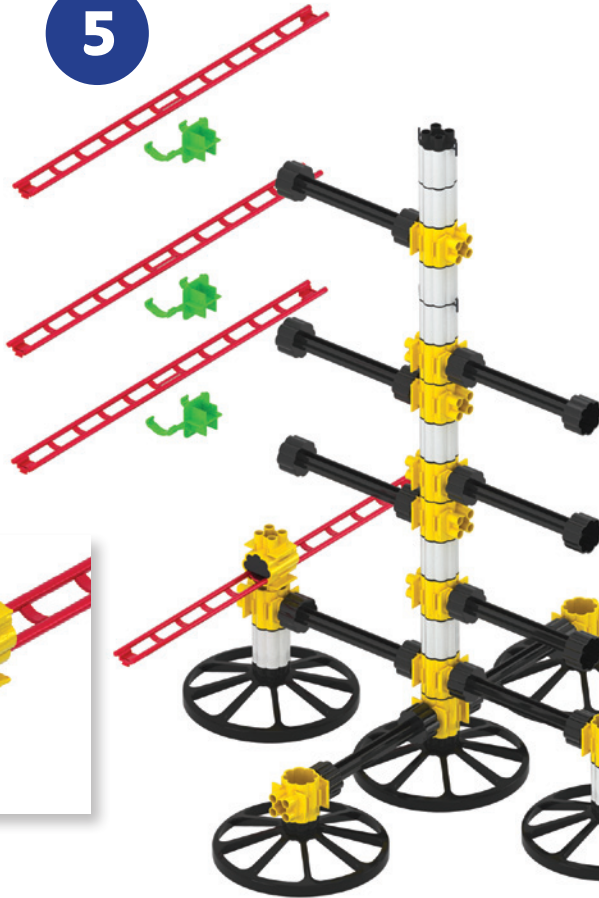
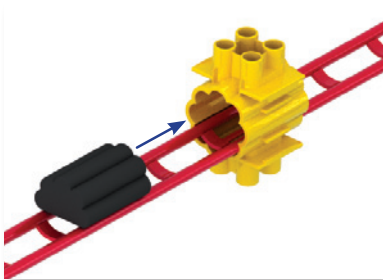

1



2



3

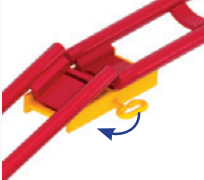

4



6

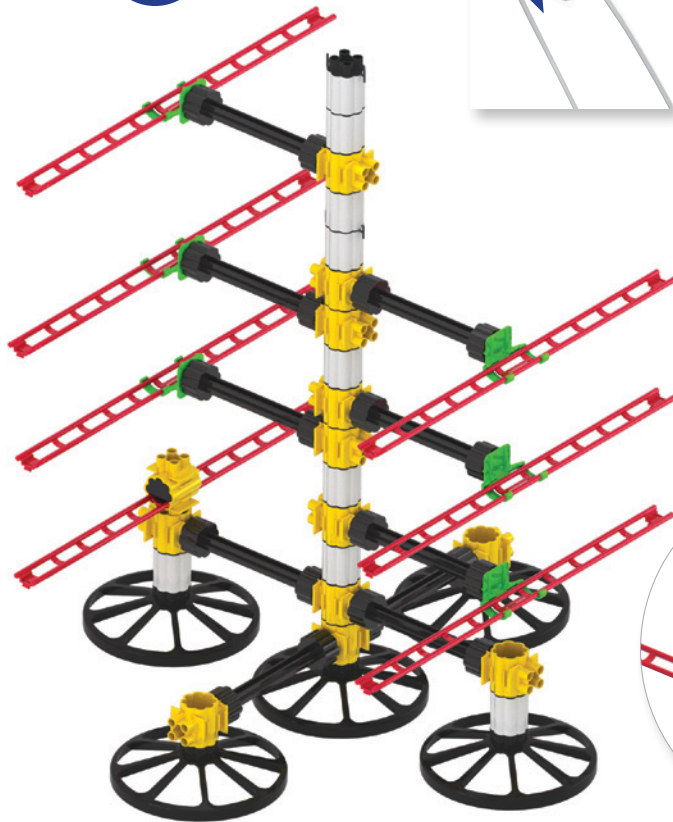

A



B



C



D



click

E

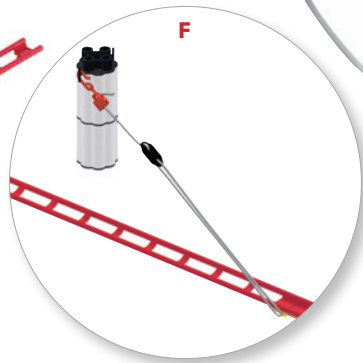

F

7

ITA Quando hai finito di montare la pista, regola accuratamente la lunghezza dei cavi (facendo scorrere su è giù il cursore nero). Per verificare se i vari tratti della pista hanno la corretta pendenza, fai correre qualche biglia a mano.

ENG Once you have finished building the track, adjust carefully the length of the suspension cables (by sliding up and down the black cursor). To check that all the stretches of track have the correct inclination, drop a few marbles by hand.

FRA Lorsque tu as fini de monter la piste, règle avec attention la longueur des câbles en faisant glisser le curseur noir. Pour vérifier si les divers segments de la piste ont une inclinaison correcte, fais rouler quelques billes manuellement.

ESP Una vez acabado el montaje de las pistas, regula con cuidado la longitud de los cables de suspensión, deslizando el tensor negro. Para comprobar que todos los tramos de la pista tienen la inclinación correcta, haz rodar algunas canicas manualmente.

DEU Wenn Sie die Kugelbahn fertig gestellt haben, passen Sie behutsam die Länge der Kabelaufhängung an. Um zu Prüfen, dass alle Streckenteile korrekt zusammengesetzt wurden, lassen Sie einige Murmeln per Hand die Bahn hinunterlaufen.

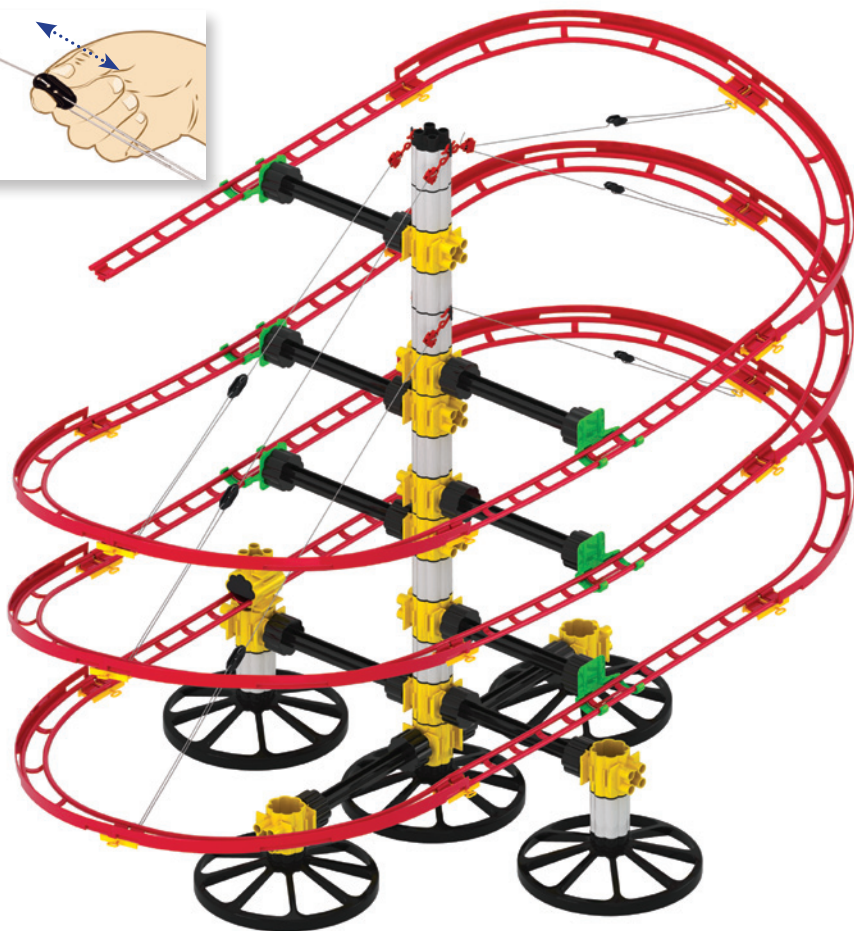
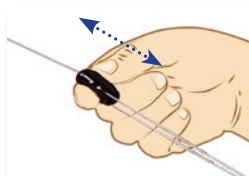

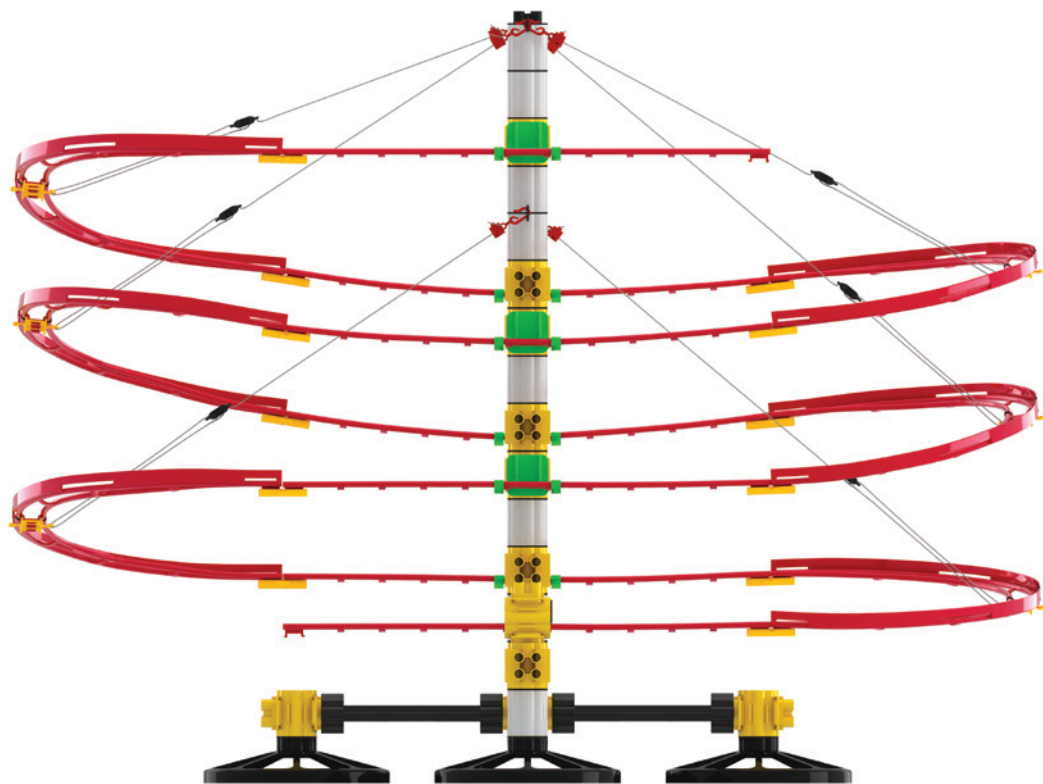
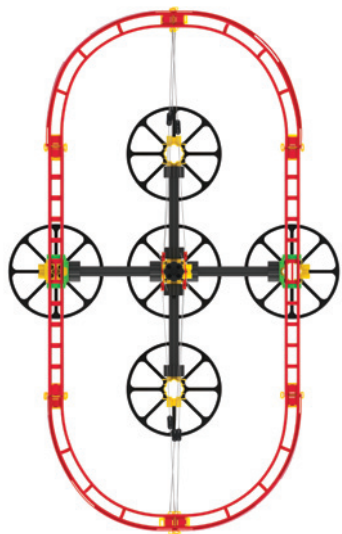

ITA Con Skyrail Ottovolante puoi costruire fantastiche piste sospese per biglie fino a 12 o 20 metri di spettacolare sviluppo aereo, facendole diventare così, da subito, le protagoniste assolute della tua cameretta. I percorsi sono resi ancora più entusiasmanti grazie alle nuove curve paraboliche complete di sponda per realizzare percorsi ancora più arditi ed emozionanti. Tutti gli elementi sono accuratamente progettati in modo da poter utilizzare le 8 biglie in dotazione nel diametro 19 mm ma anche palline di diverse dimensioni e materiali che permettono di fare interessanti osservazioni, esperimenti e scoperte nel mondo della fisica (velocità, gravità, forza centrifuga, attrito) e di comprenderne intuitivamente i principi fondamentali. Tutto questo ne fa un gioco dall'eccezionale e unico valore educativo che assicura lunghe ore di gioco in piena sicurezza.

ENG With Skyrail Ottovolante you can build fantastic suspended marble tracks for up to 12 or 20 meters of spectacular aerial development that can instantly become the absolute superstar of your bedroom. The tracks are even more exciting thanks to the new parabolic curves complete with edges so you can create even

more daring and exciting tracks. All parts are accurately designed so you can use the 8 marbles included, of 19 mm in diameter, but also marbles of different sizes and materials, allowing you to make interesting observations, experiments and discoveries in the world of physics (speed, gravity, centrifugal force, friction) and intuitively understand the fundamental principles. All of this makes for a game of exceptional and unique educational value, ensuring long hours of play in complete safety.

FRA Avec Skyrail Grand Huit tu peux construire de merveilleuses pistes suspendues se développant sur 12 ou 20 mètres pour que tes billes deviennent les protagonistes de ta chambre. Les circuits sont ainsi encore plus intéressants, grâce aux nouvelles courbes paraboliques équipées de bordures pour réaliser des parcours encore plus difficiles et palpitants. Tous les éléments sont conçus afin de pouvoir utiliser les 8 billes de 19 mm de diamètre incluses dans la boîte de jeu, mais aussi des billes de dimensions et de matériaux différents qui permettent de faire des observations intéressantes, des expériences et des découvertes sur le monde de la physique (vitesse, gravité, force centrifuge, frottement) et d'en

comprendre de manière intuitive les principes fondamentaux. Tout cela rend le jeu exceptionnel et unique d'un point de vue éducatif et assure de longues heures de jeu en toute sécurité.

ESP Con Skyrail Montaña Rusa puedes construir fantásticas pistas colgantes de hasta 12 o 20 metros para tus canicas. Un espectacular recorrido aéreo que las convertirá inmediatamente en las protagonistas de tu cuarto. Los trayectos se vuelven aún más entusiasmantes gracias a las nuevas curvas parabólicas que permiten realizar recorridos más arduos y emocionantes. Todos los elementos han sido especialmente cuidados para utilizar las ocho canicas incluidas para el diámetro de 19 milímetros. Pero también podrás utilizar otras bolas de diferentes dimensiones y materiales que te permitirán realizar interesantes observaciones, experimentos y descubrimientos en el mundo de la física (velocidad, gravedad, fuerza centrífuga o rozamiento) y comprender de manera intuitiva sus principios fundamentales. Todo esto lo convierte en un juego de un valor excepcional y único a nivel educativo, que, además, asegura largas horas de juego en condiciones de plena seguridad.



Mit Skyrail Achterbahn kannst du fantastische Murmelbahnen bauen, die bis zu 12 oder 20 Meter lang sein können und auf spektakuläre Weise in die Höhe wachsen. - So werden sie von Anfang an die Absolute Hauptattraktion in deinem Zimmer. Die Strecken sind dank der neuen Steilkurven noch mitreißender und die Leitplanken erlauben es dir, noch gewagtere und aufregendere Strecken zu kreieren. Alle Elemente sind genau dafür ausgelegt, um die 8 mitgelieferten Murmeln im Durchmesser von 19 mm, aber auch andere Kugeln verschiedener Größen und Materialien zu verwenden, die es erlauben interessante Entdeckungen und Experimente in der Welt der Physik (Geschwindigkeit, Schwerkraft, Fliehkraft, Reibung) zu machen und diese intuitiv in ihren Grundprinzipien zu begreifen. All das macht aus der Skyrail Achterbahn ein ganz besonderes Spielzeug mit hohem erzieherischen Wert, das ein langes Spielvergnügen mit voller Sicherheit garantiert.

6660 / 6665

Skyrail

Ottovolante & Ottovolante maxi

L3 / 13-26x



L2 / 5-10x



L1 / 5-19x



20-40x

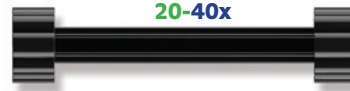

20-40x



4-6x



38-72x



46-75x



8-8x



2-6x

1-1x



30-46x



15-30x

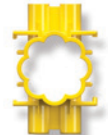

23-34x



6660 Skyrail

Ottovolante

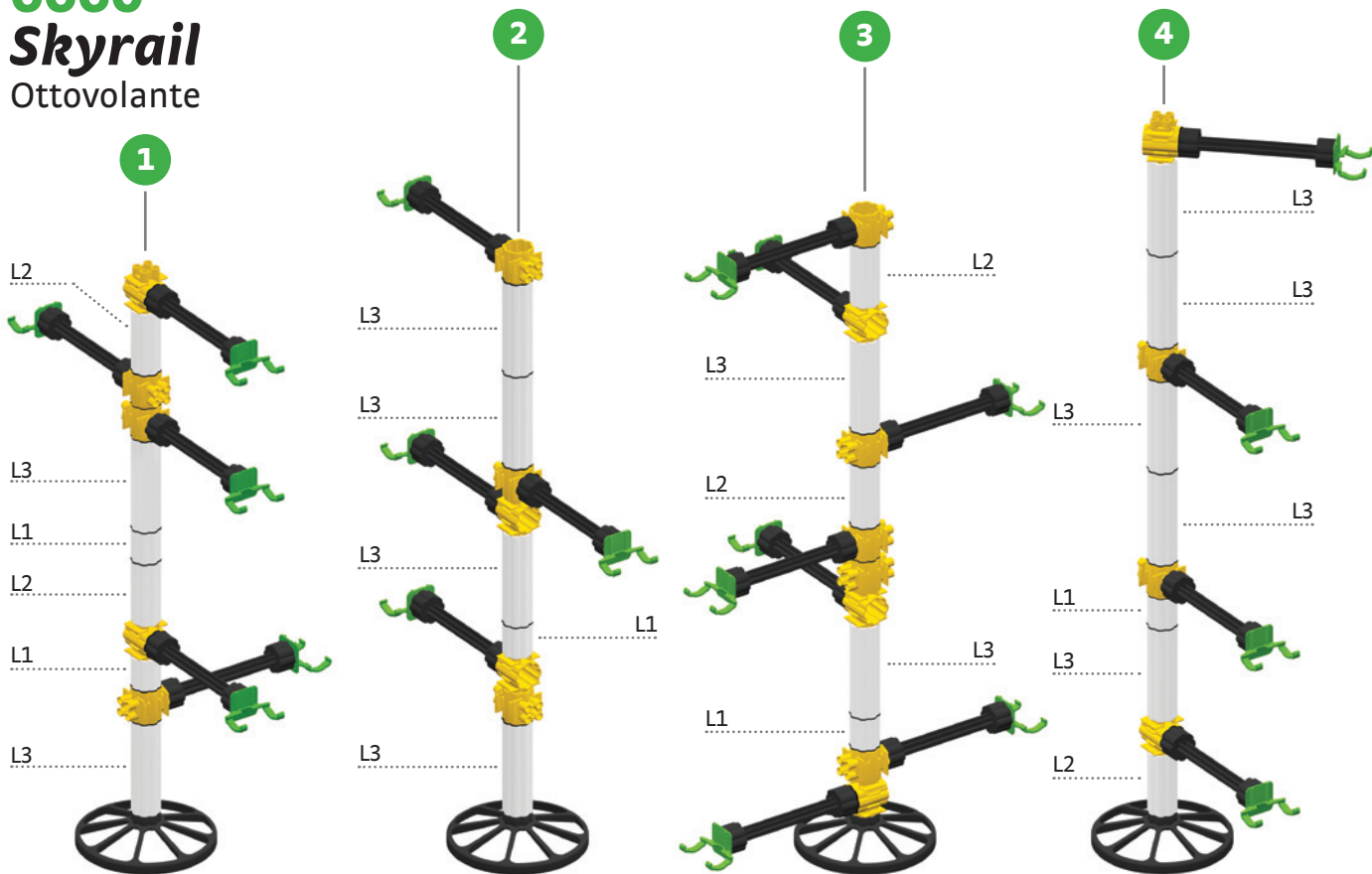

12 metri di pista
13.12 yards of track
12 metres de piste
12 metros de pista
12 Meter an Kugelbahnen

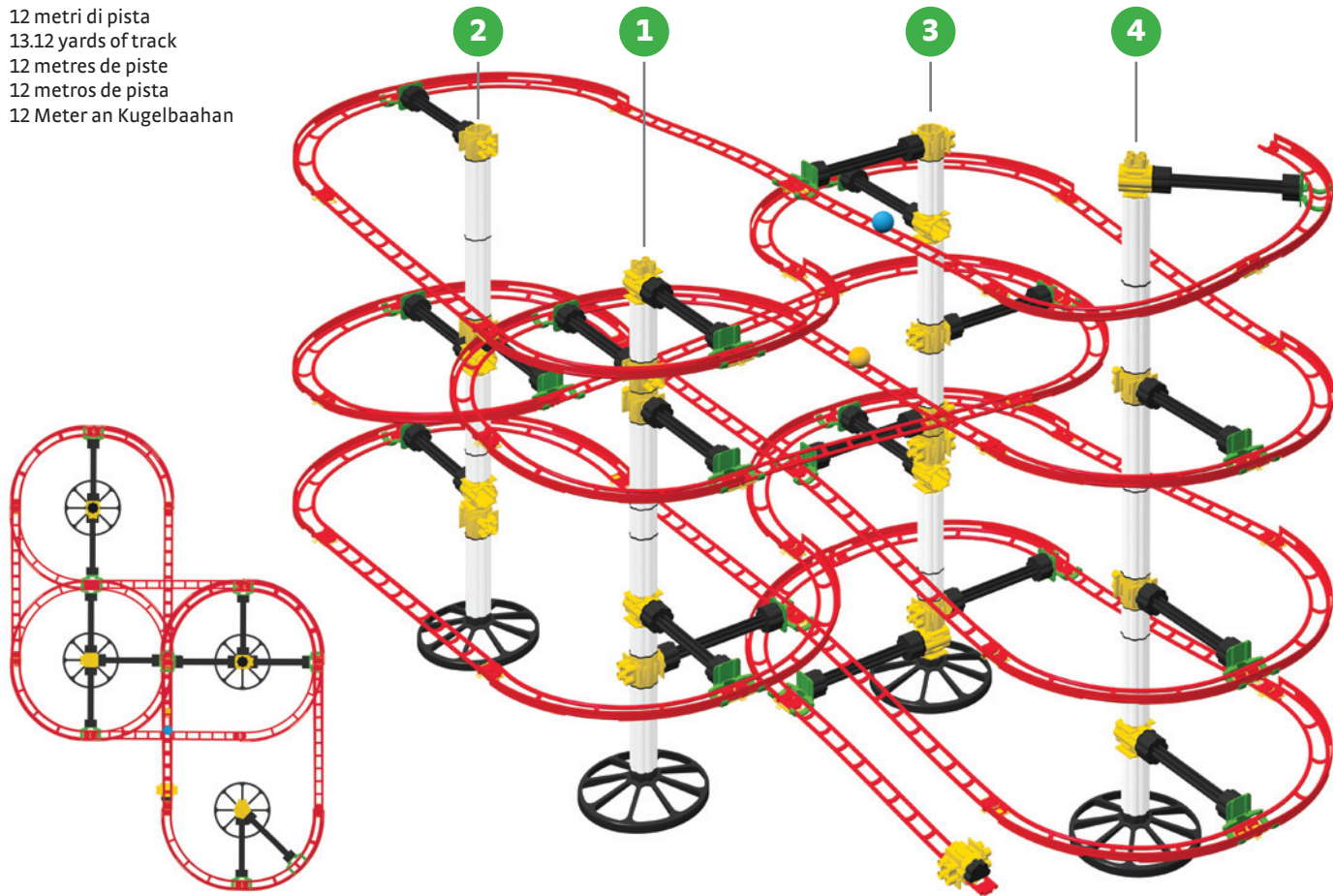

6665 Skyrail

Ottovolante
maxi

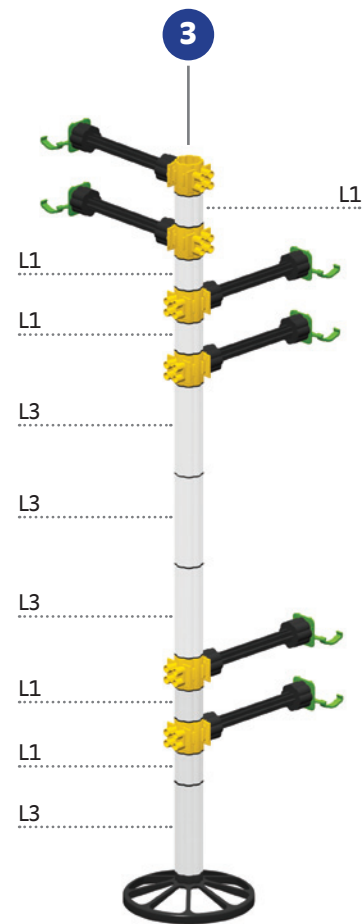
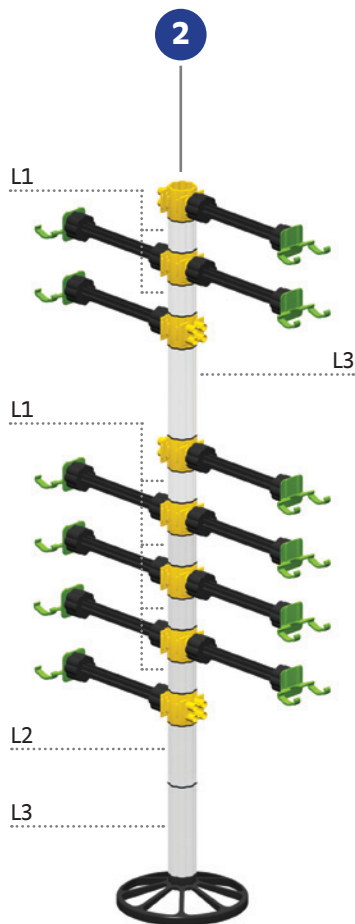
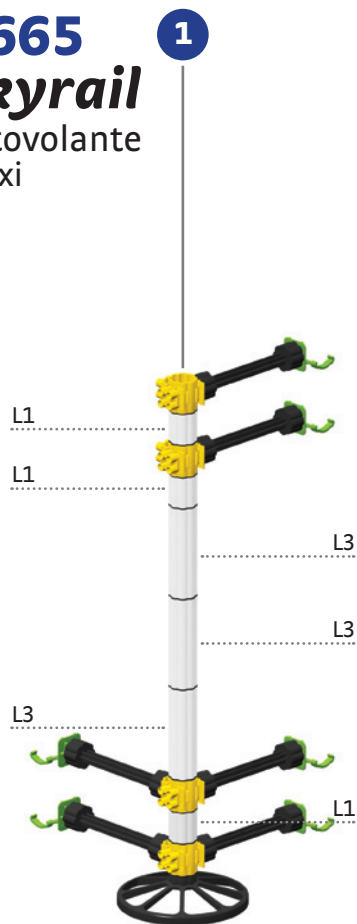

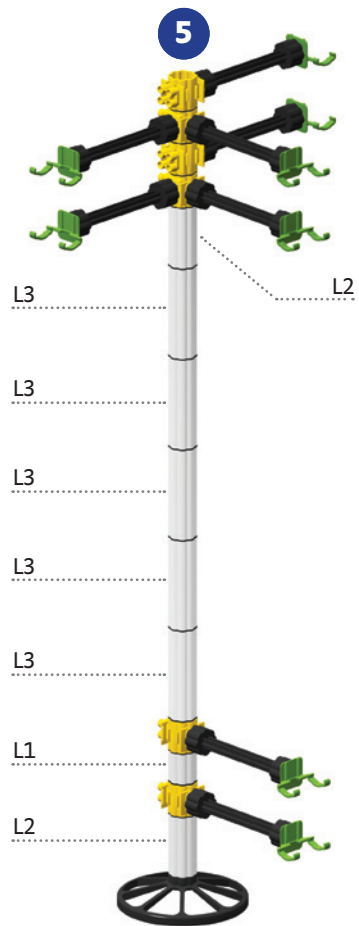
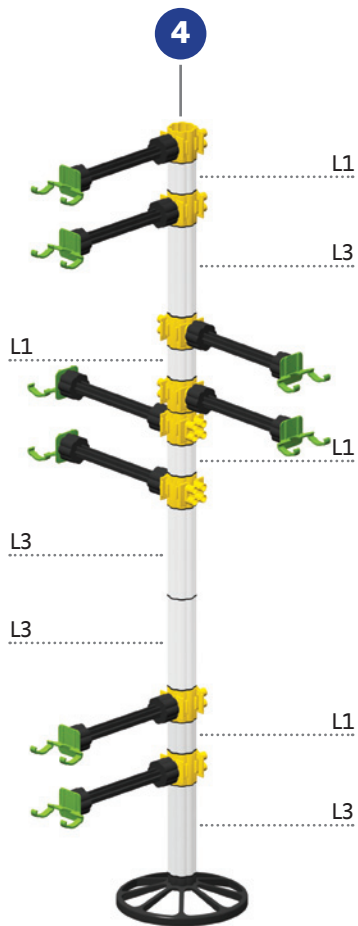

6665 *Skyrail* Ottovolante maxi

20 metri di pista
21.87 yards of track
20 metres de piste
20 metros de pista
20 Meter an Kugelbahnen

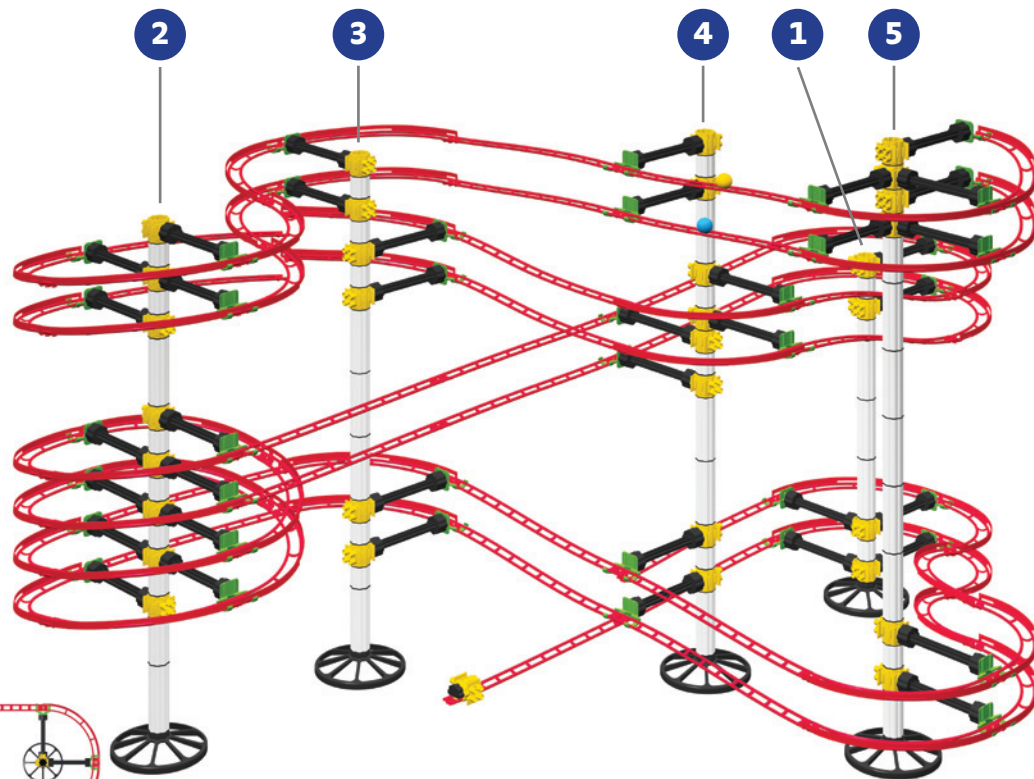
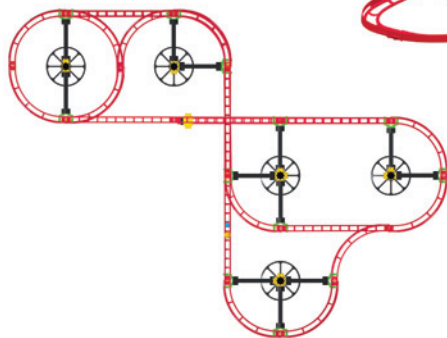

6661

Skylrail

Ottovolante
elevator

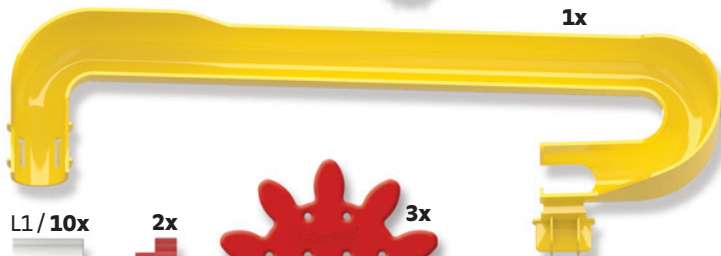
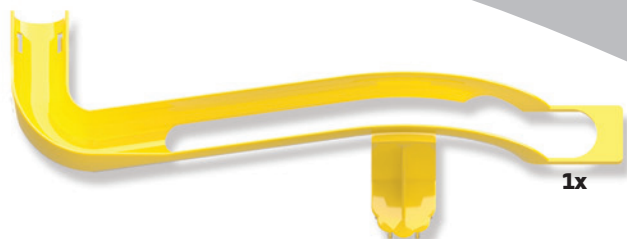

L1/10x

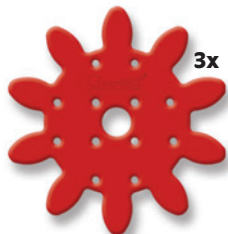

L2/14x

L3/9x



47x

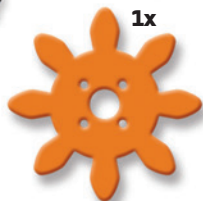

M3/2x

M4/29x



2x



2x



2x



2x



2x

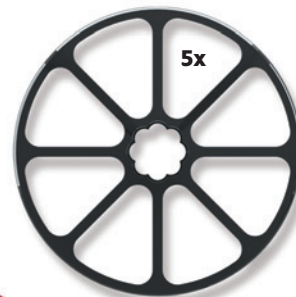

6661 Skyrail

Ottovolante
elevatore

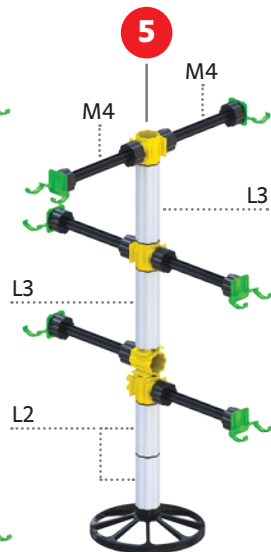
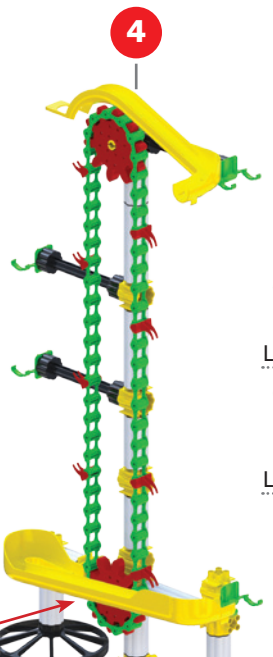
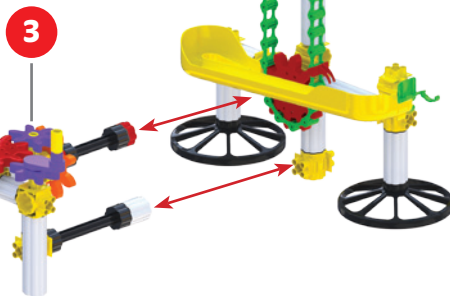
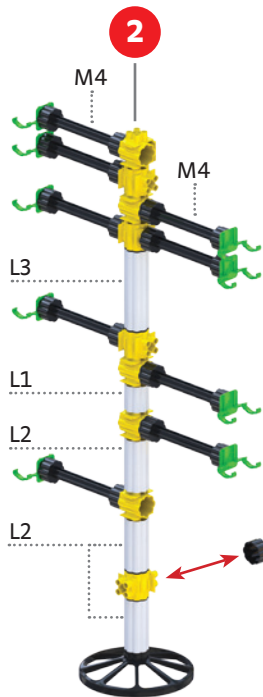
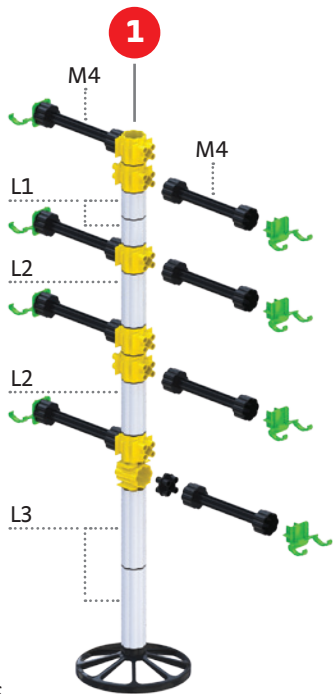

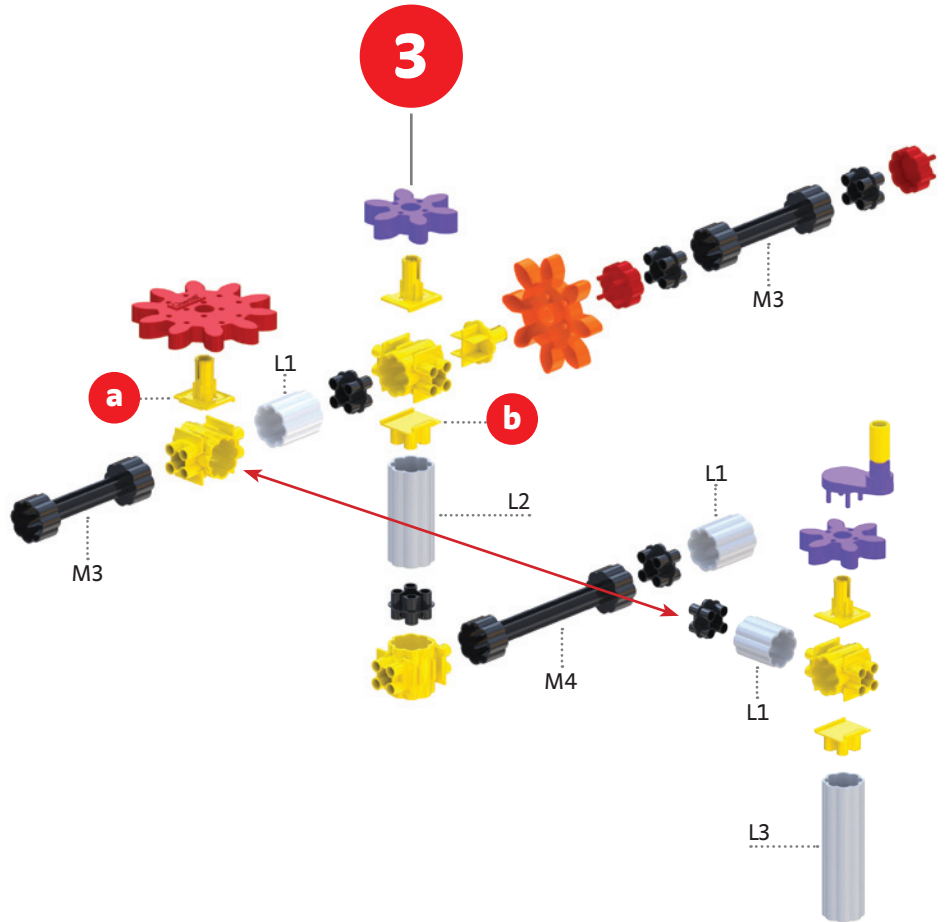
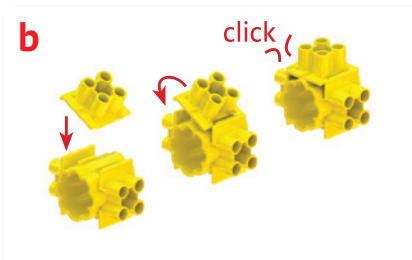
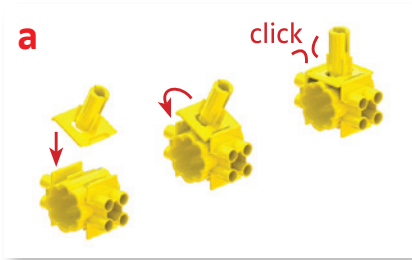

4

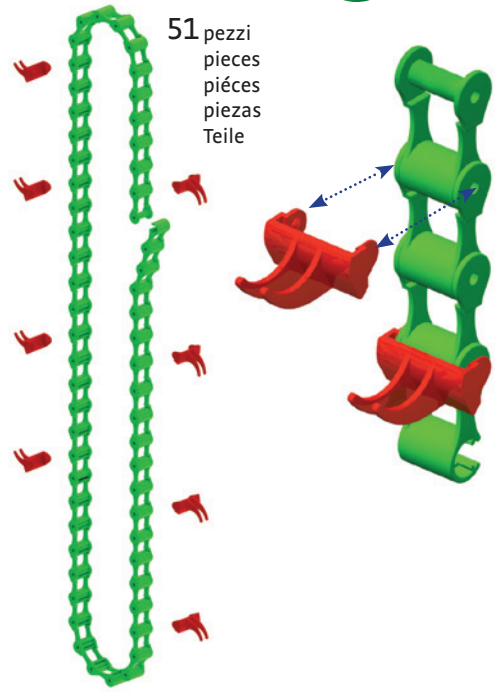
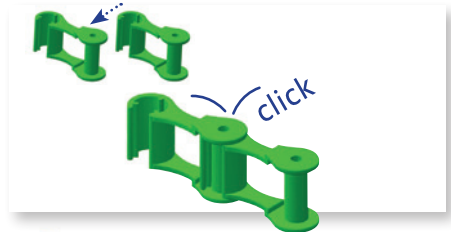
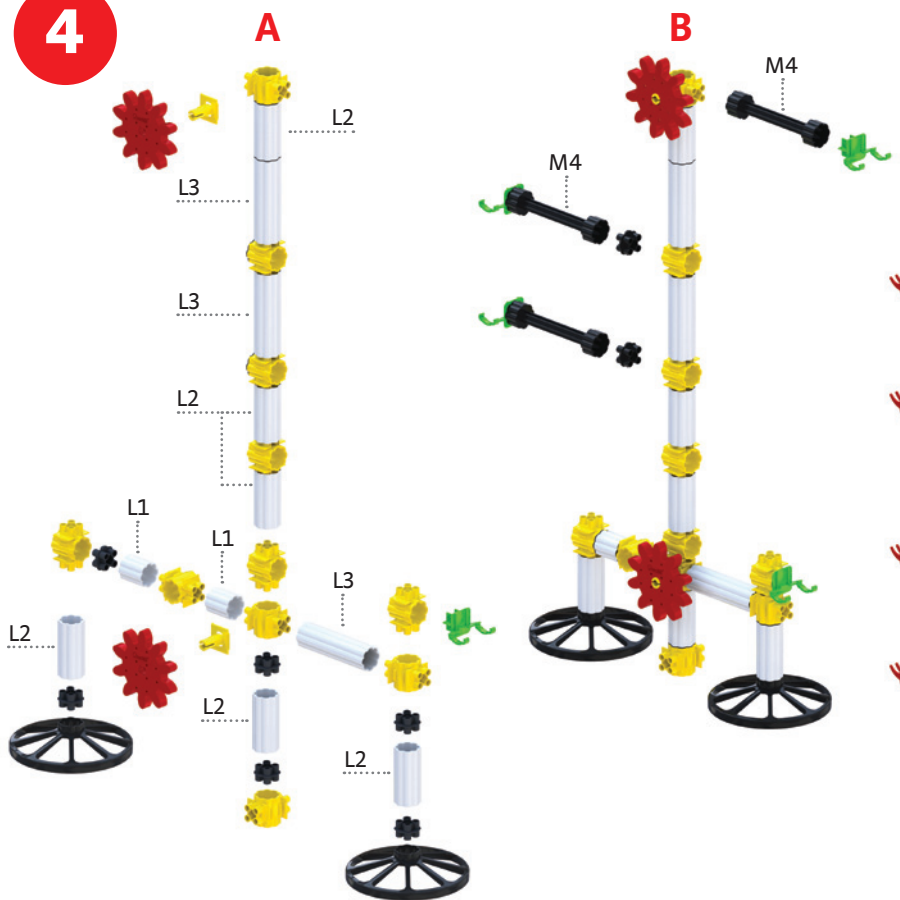

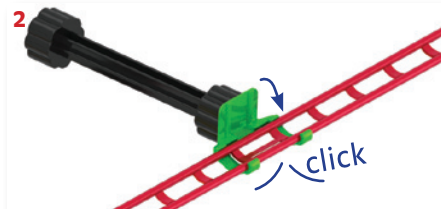
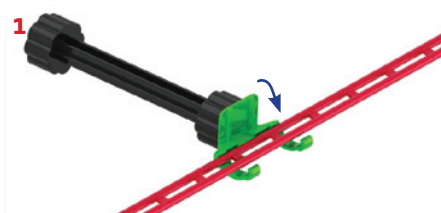
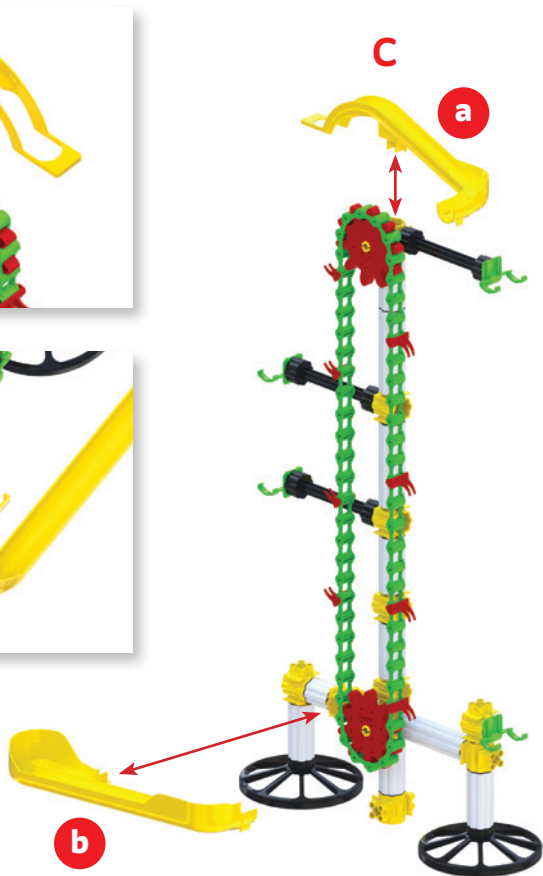

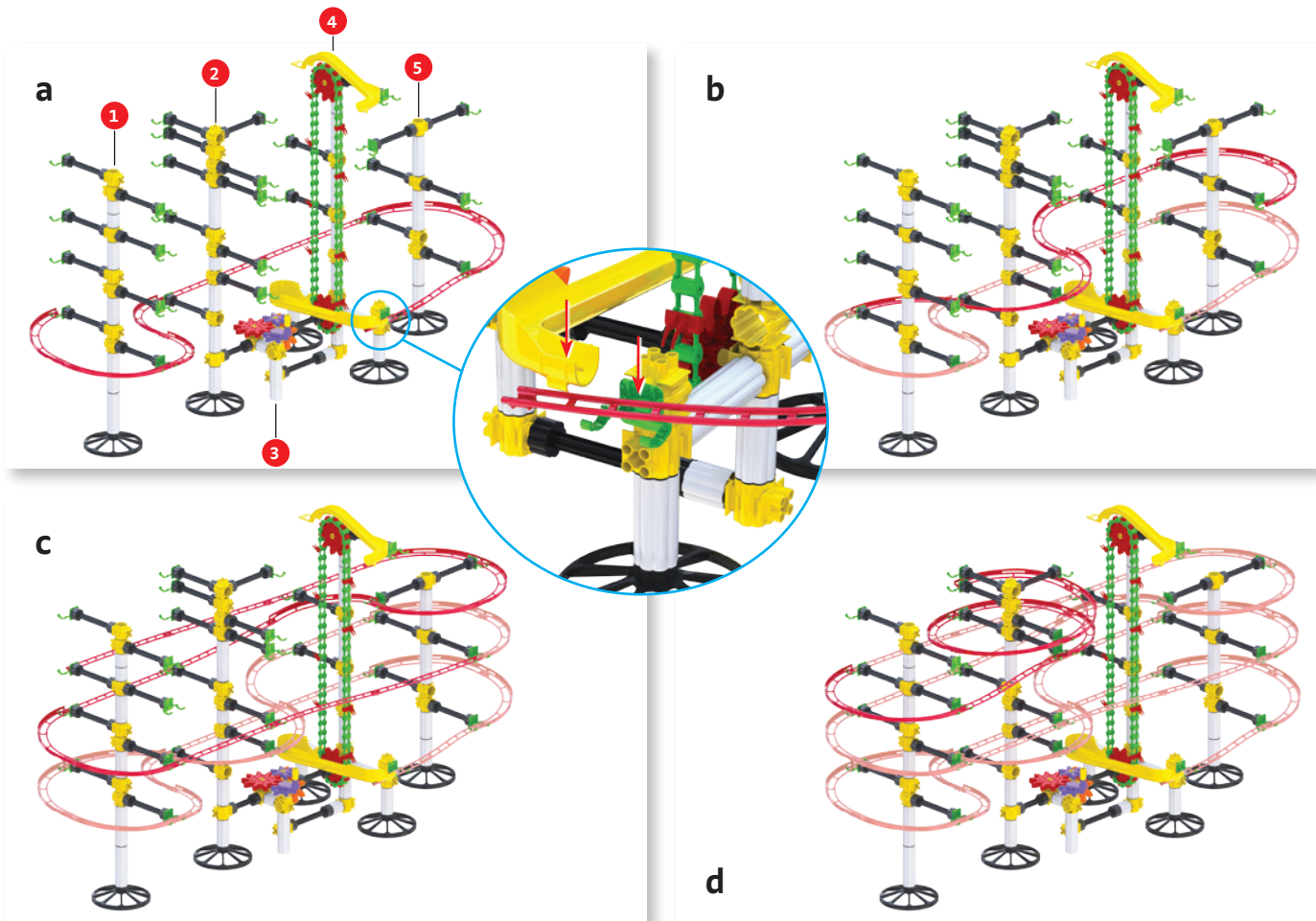

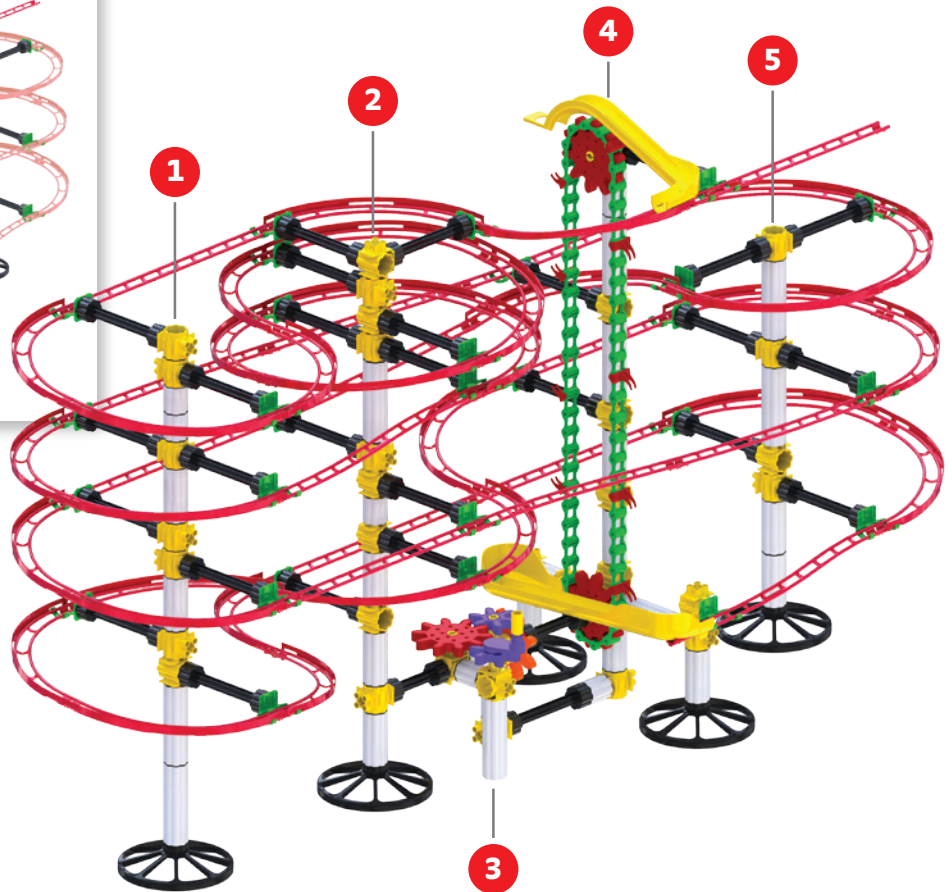
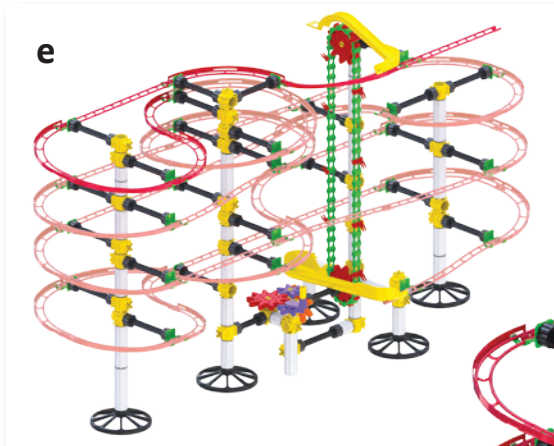

12 metri di pista
13.12 yards of track
12 metres de piste
12 metros de pista
12 Meter an Kugelbaahan



giocare intelligente.